

- a full body harness (conforming to EN 361) is the only acceptable body holding device that can be used in a fall arrest system.
- in full body harness use only attaching points marked with big letter "A" to attach a fall arrest system.
- the anchor device or anchor point for the fall arrest system should always be positioned, and the work carried out in such a way, as to minimise both the potential for falls and potential fall distance. The anchor device/point should be placed above the position of the user. The shape and construction of the anchor device/point shall not allowed to self-acting disconnection of the equipment. Minimal static strength of the anchor device/point is 10 kN. It is recommended to use certified and marked structural anchor point complied with EN795
- it is obligatory to verify the free space required beneath the user at the workplace before each occasion of use the fall arrest system, so that, in the case of a fall, there will be no collision with the ground or other obstacle in the fall path. The required value of the free space should be taken from instruction manual of used equipment.
- there are many hazards that may affect the performance of the equipment and corresponding safety precautions that have to be observed during equipment utilization, especially: - trailing or looping of lanyards or lifelines over sharp edges, - any defects like cutting, abrasion, corrosion, - climatic exposure, - pendulum falls, - extremes of temperature, - chemical reagents, - electrical conductivity.
- personal protective equipment must be transported in the package (e.g.: bag made of moisture-proof textile or foil bag or cases made of steel or plastic) to protect it against damage or moisture.
- the equipment can be cleaned without causing adverse effect on the materials in the manufacture of the equipment. For textile products use mild detergents for delicate fabrics, wash by hand or in a machine and rinse in water. Plastic parts can be cleaned only with water. When the equipment becomes wet, either from being in use or when due cleaning, it shall be allowed to dry naturally, and shall be kept away from direct heat. In metallic products some mechanic parts (spring, pin, hinge, etc.) can be regularly slightly lubricated to ensure better operation. Other maintenance and cleaning procedures should be adhered to detailed instructions stated in the manual of the equipment.
- personal protective equipment should be stored loosely packed, in a well-ventilated place, protected from direct light, ultraviolet degradation, damp environment, sharp edges, extreme temperatures and corrosive or aggressive substances.

IT IS THE RESPONSIBILITY OF THE USER ORGANISATION TO PROVIDE THE IDENTITY CARD AND TO FILL IN THE DETAILS REQUIRED. THE IDENTITY CARD SHOULD BE FILLED IN BEFORE THE FIRST USE BY A COMPETENT PERSON, RESPONSIBLE IN THE USER ORGANIZATION FOR PROTECTIVE EQUIPMENT. ANY INFORMATION ABOUT THE EQUIPMENT LIKE PERIODIC INSPECTIONS, REPAIRS, REASONS OF EQUIPMENT'S WITHDRAWN FROM USE SHALL BE NOTED INTO THE IDENTITY CARD BY A COMPETENT PERSON. THE IDENTITY CARD SHOULD BE STORED DURING A WHOLE PERIOD OF EQUIPMENT UTILIZATION. DO NOT USE THE EQUIPMENT WITHOUT THE IDENTITY CARD. ALL RECORDS IN THE IDENTITY CARD CAN BE FILLED IN ONLY BY A COMPETENT PERSON.

## IDENTITY CARD

MODEL AND TYPE OF EQUIPMENT		REF. NUMBER	
SERIAL NUMBER		DATE OF MANUF.	
USER NAME			
DATE OF PURCHASE		DATE OF PUTTING INTO OPERATION	

### PERIODIC EXAMINATION AND REPAIR HISTORY

	DATE	REASON FOR ENTRY PERIODIC EXAMINATION OR REPAIR	DEFECTS NOTED, REPAIRS CARRIED OUT AND OTHER RELEVANT INFORMATIONS	NAME AND SIGNATURE OF COMPETENT PERSON	PERIODIC EXAMINATION NEXT DUE DATE
1					
2					
3					
4					

PROTEKT, 93-403 LODZ,  
ul. Starorudzka 9, POLAND,  
TEL: (48 42) 680 20 83, FAX: (48 42) 680 20 93  
www.protekt.com.pl

Notified body, at which the European certification was performed and which supervises the production of the equipment:

APAVE SUDEUROPE SAS - BP 193 - 13322 MARSEILLE CEDEX 16 - FRANCE

# Instruction Manual

READ CAREFULLY BEFORE USE THE EQUIPMENT

# PROTEKT®

CE 0082 EN 361:2002  
EN 358:1999  
EN 813:2008

**SAFETY HARNESS** P-71 P-71E P-71C  
Ref. AB 171 01 Ref. AB 171 02 Ref. AB 171 03

Safety harness is the basic element of fall arrest equipment.

The harness P-71/P-71E/P-71C complies with EN 361 (as a full body harness), EN 358 (as a work positioning belt) and EN 813 (as a sit harness) - the maximum load of the sit harness is 100 kg. The harness is made of polyamide webbings.

Models:

- P-71 - basic version.
- P-71E - elasticated shoulder's strap.
- P-71C - quick release buckles in the legs.

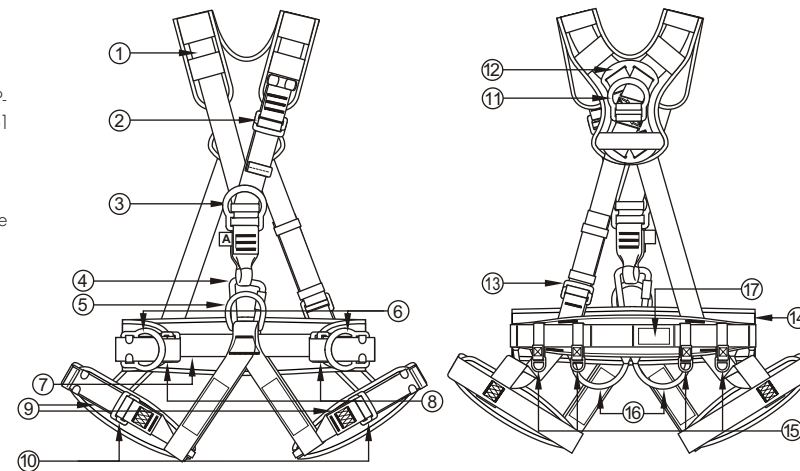

1. Shoulder strap.
2. Shoulder strap adjusting buckle.
3. Frontal attachment D-ring - for attaching fall arrest system.
4. Connecting snap hook.
5. Frontal waist attachment buckle - can be utilized as a sit harness according EN 813 (it's not allowed to use this buckle to attach fall arrest system).
6. Lateral belt attachment D-rings. Can be utilized only to attach work positioning systems according EN 358.
7. Work positioning belt strap.
8. Work positioning belt strap adjusting buckles.
9. Thigh straps.

11. Dorsal attachment D-ring - for attaching fall arrest system.
12. Crossing plate.
13. Dorsal strap adjusting buckle.
14. Belt pad.
15. Tool Plastic D-rings.
16. Tool Loops.
17. Identity label

### SIZES

The harness is manufactured in two sizes:  
- medium and extra large size - M-XL  
- extra large -XXL

### HARNESS MARKING

- a-Device type, b-Model symbol, c-Reference number, d-number/year European standards  
e-CE mark and number of the notified body controlling manufacturing of the equipment,  
f- Month and year of manufacture, g-Serial number of the harness, h-Harness size,  
i-Caution: read the manual, j- identification of the harness manufacturer or distributor.  
k - max. weight for the sit harness use.

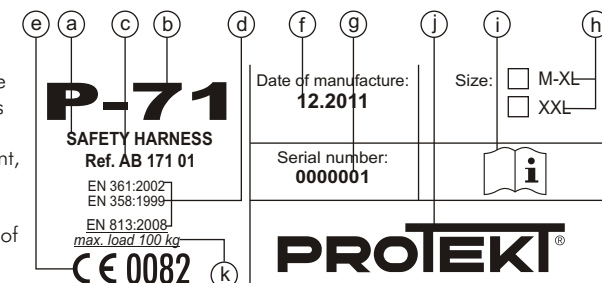

**PROTEKT®**

## PUTTING ON THE HARNESS

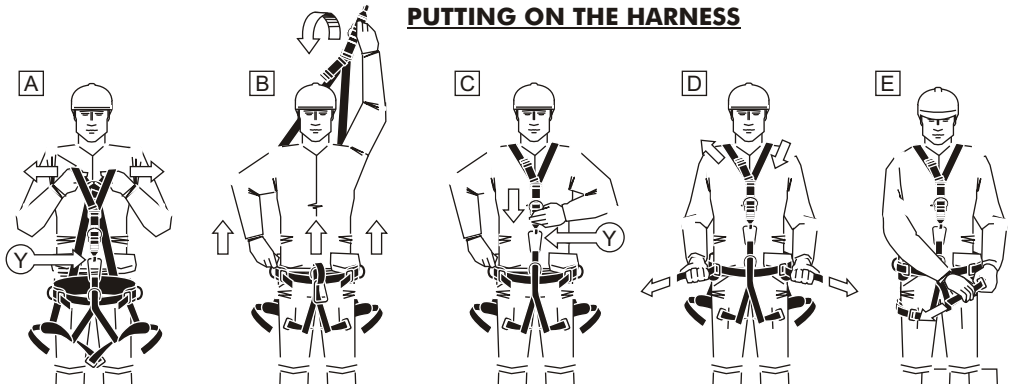

- A.** Take the harness by the shoulder straps. Disconnect shoulder straps from connecting hook [Y].
- B.** Move the straps over the head. Taking the harness by the belt, put them on over the feet.
- C.** Connect shoulder straps to connecting hook [Y].
- D.** Adjust the belt strap. Necessarily protect free ends of the straps with the loops. Adjust the shoulder straps.
- E.** Fasten and adjust the thigh straps. Necessarily protect free ends of the straps with the loops.

### Fastening the straps

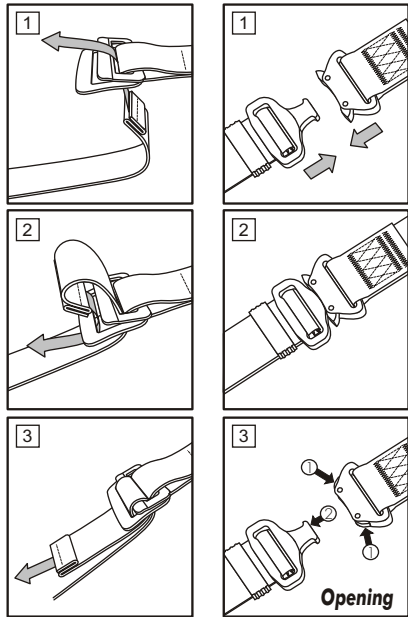

### Harness is put on correctly if:

- all straps are correctly adjusted (neither too loose nor too tight).
- back attaching buckle is correctly positioned at the level of the shoulder blades.
- front connecting snap hook is correctly positioned at the middle of the chest.
- the ends of the all straps must be kept by plastic loops.

### ADMISSIBLE TIME OF USE

Safety harness can be used for 5 years. After this period the harness must be withdrawn from use to carry out manufacturer's detailed inspection

The manufacturer's inspection can be carried out by:

- manufacturer
- or person recommended by manufacturer
- or company recommended by manufacturer.

During this inspection will be established admissible time of harness use till next manufacturer's inspection.

### ATTENTION:

**Always protect free end of the strap with the loop**

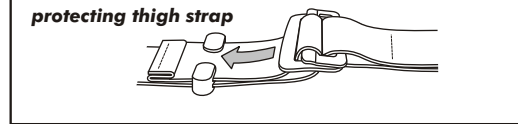
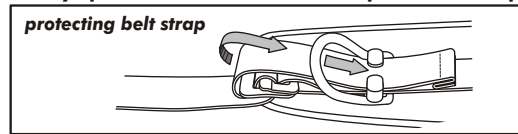

### Adjusting the straps

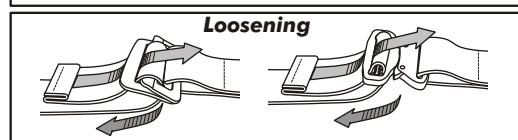
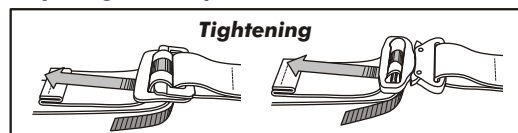

**ATTENTION:** Before use the belt the first time the user should carry out a suspension test in a safe place to ensure that the sit harness is the correct size, has sufficient adjustment and is of an acceptable comfort level for the intended use.

## ATTACHING FALL ARREST SYSTEM

- Fall arrest system must be connected only to the attaching elements of the harness marked by capital letter A. The fall arrest system must be connected only to: - dorsal attachment D-ring - drawing (1) or - to frontal attachment D-ring. The dorsal attachment D-ring is marked by a capital letter A - embossed on the crossing plate. Front attachment D-ring is marked by a capital letter A placed on the label sewn near the D-ring. See drawings.
- work positioning system can be attached only to the lateral buckles of the work positioning belt or to the frontal waist buckle - work positioning lanyard must be anchored to the point of construction that is situated at waist level or above. Work positioning lanyard must be kept taut to restrict free movement to a maximum 0,6 m.

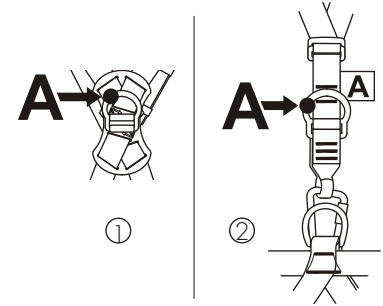

### WARNING:

- 1) It is strictly forbidden to attach any fall arrest system to side buckle of work positioning belt.
- 2) It is strictly forbidden to attach any fall arrest system to frontal buckle designed for use as a sit harness according EN 813.

## THE ESSENTIAL PRINCIPLES FOR USERS OF PERSONAL PROTECTIVE EQUIPMENT AGAINST FALLS FROM A HEIGHT

- personal protective equipment shall only be used by a person trained and competent in its safe use.
- personal protective equipment must not be used by a person with medical condition that could affect the safety of the equipment user in normal and emergency use.
- a rescue plan shall be in place to deal with any emergencies that could arise during the work.
- being suspended in PPE (e.g. arresting a fall), beware of suspension trauma symptoms.
- to avoid symptoms of suspension trauma, be sure that the proper rescue plan is ready for use. It is recommended to use foot straps.
- it is forbidden to make any alterations or additions to the equipment without the manufacturer's prior written consent.
- any repair shall only be carried out by equipment manufacturer or his certified representative.
- personal protective equipment shall not be used outside its limitations, or for any purpose other than that for which it is intended.
- personal protective equipment should be a personal issue item.
- before use ensure about the compatibility of items of equipment assembled into a fall arrest system. Periodically check connecting and adjusting of the equipment components to avoid accidental loosening or disconnecting of the components.
- it is forbidden to use combinations of items of equipment in which the safe function of any one item is affected by or interferes with the safe function of another.
- before each use of personal protective equipment it is obligatory to carry out a pre-use check of the equipment, to ensure that it is in a serviceable condition and operates correctly before it is used.
- during pre-use check it is necessary to inspect all elements of the equipment in respect of any damages, excessive wear, corrosion, abrasion, cutting or incorrect acting, especially take into consideration:
  - in full body harnesses and belts - buckles, adjusting elements, attaching points, webbings, seams, loops;
  - in energy absorbers - attaching loops, webbing, seams, casing, connectors;
  - in textile lanyards or lifelines or guidelines - rope, loops, thimbles, connectors, adjusting element, splices;
  - in steel lanyards or lifelines or guidelines - cable, wires, clips, ferrules, loops, thimbles, connectors, adjusting elements;
  - in retractable fall arresters - cable or webbing, retractor and brake proper acting, casing, energy absorber, connector;
  - in guided type fall arresters - body of the fall arrester, sliding function, locking gear acting, rivets and screws, connector, energy absorber;
  - in connectors - main body, rivets, gate, locking gear acting.
- after every 12 months of utilization, personal protective equipment must be withdrawn from use to carry out periodical detailed inspection. The periodic inspection must be carried out by a competent person for periodic inspection. The periodic inspection can be carried out also by the manufacturer or his authorized representative.
  - In case of some types of the complex equipment e.g. some types of retractable fall arresters the annual inspection can be carried out only by the manufacturer or his authorized representative.
- regular periodic inspections are the essential for equipment maintenance and the safety of the users which depends upon the continued efficiency and durability of the equipment.
- during periodic inspection it is necessary to check the legibility of the equipment marking.
- it is essential for the safety of the user that if the product is re-sold outside the original country of destination the reseller shall provide instructions for use, for maintenance, for periodic examination and for repair in language of the country in which the product is to be used.
- personal protective equipment must be withdrawn from use immediately when any doubt arise about its condition for safe use and not used again until confirmed in writing by equipment manufacturer or his representative after carried out the detailed inspection.
- personal protective equipment must be withdrawn from use immediately and destroyed (or another procedures shall be introduced according detailed instruction from equipment manual) when it have been used to arrest a fall.